

OAK 44 6x3

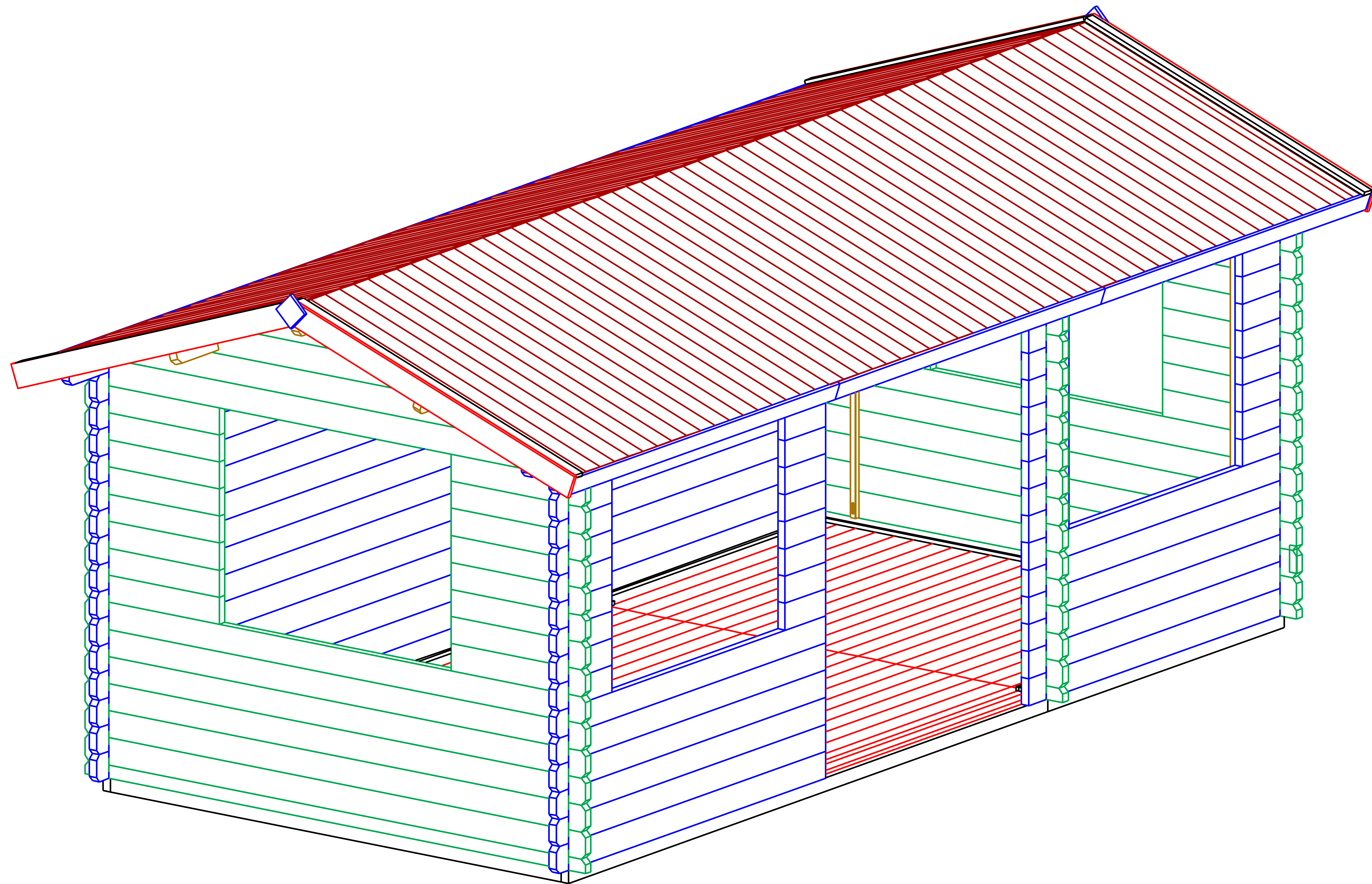

OAK 44 6x3

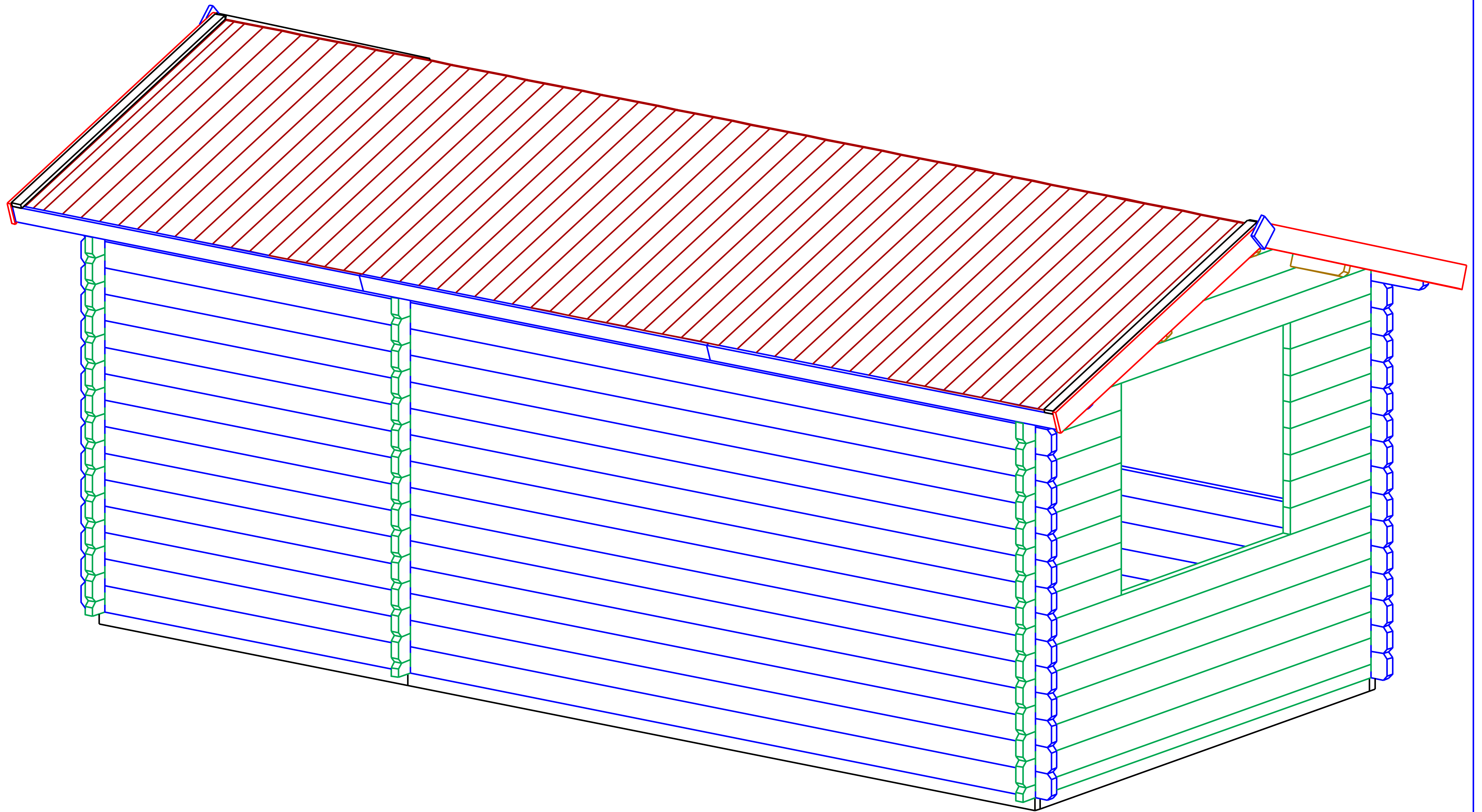

OAK 44 6x3

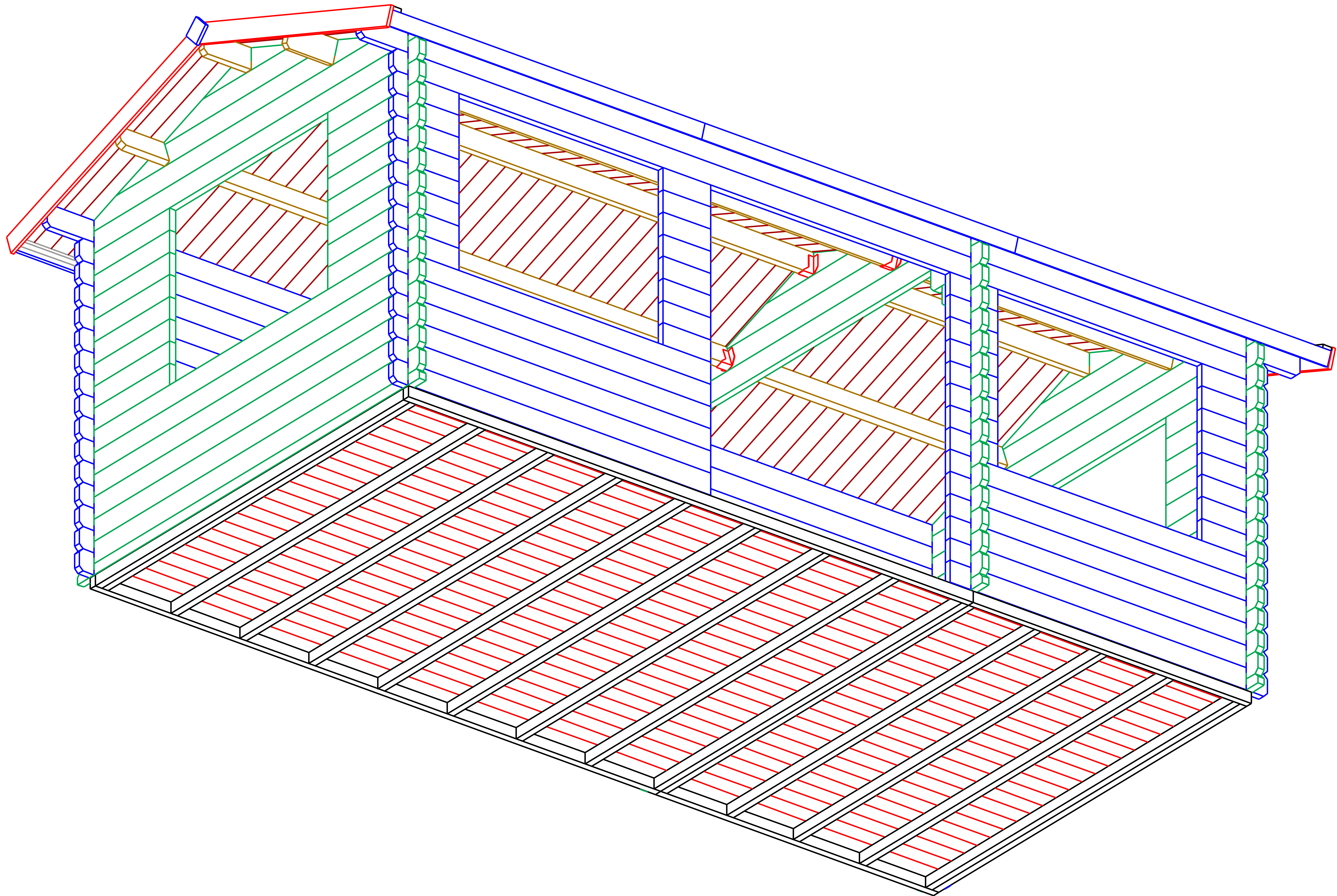

OAK 44 6x3

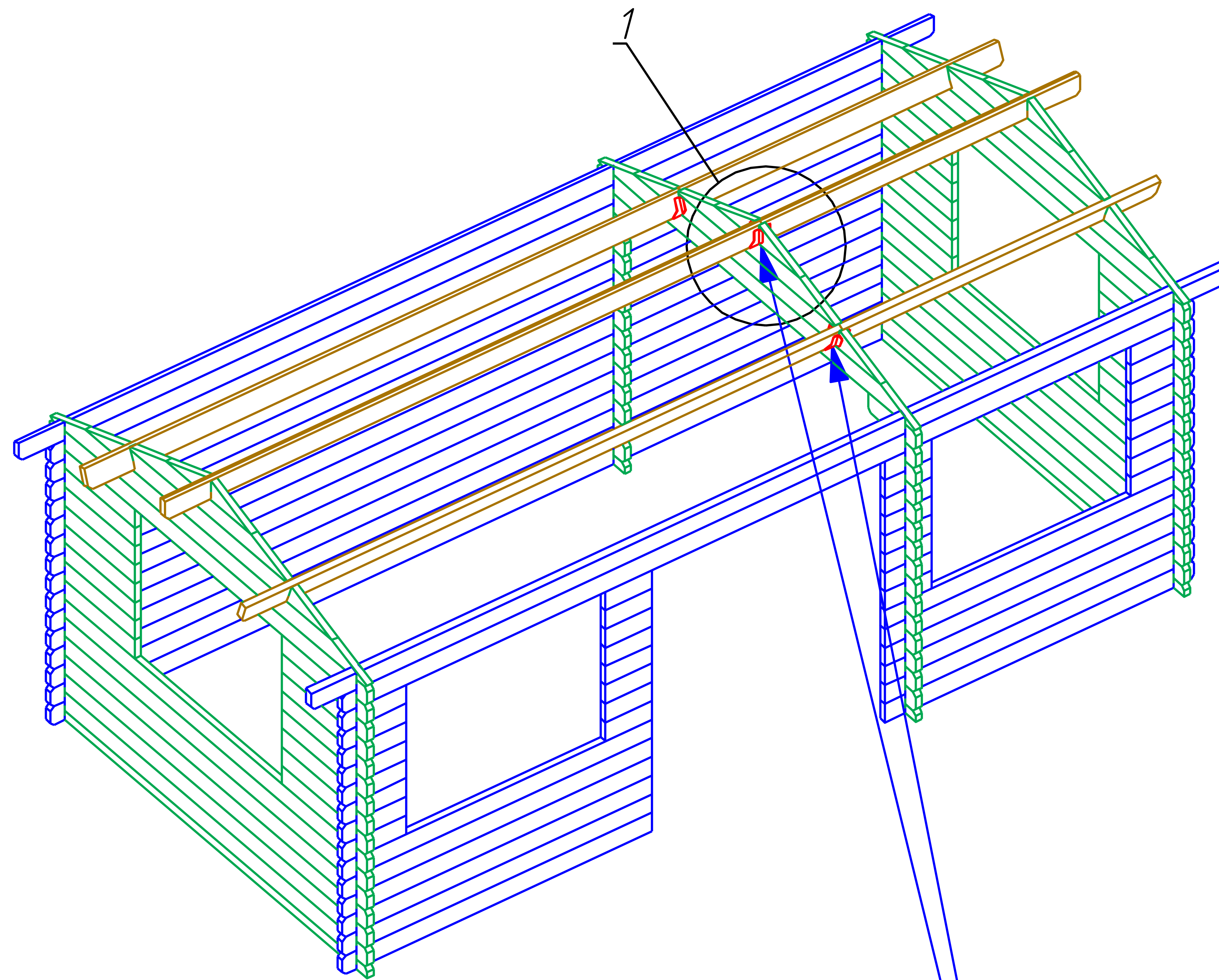

$\frac{1}{M 1:10}$

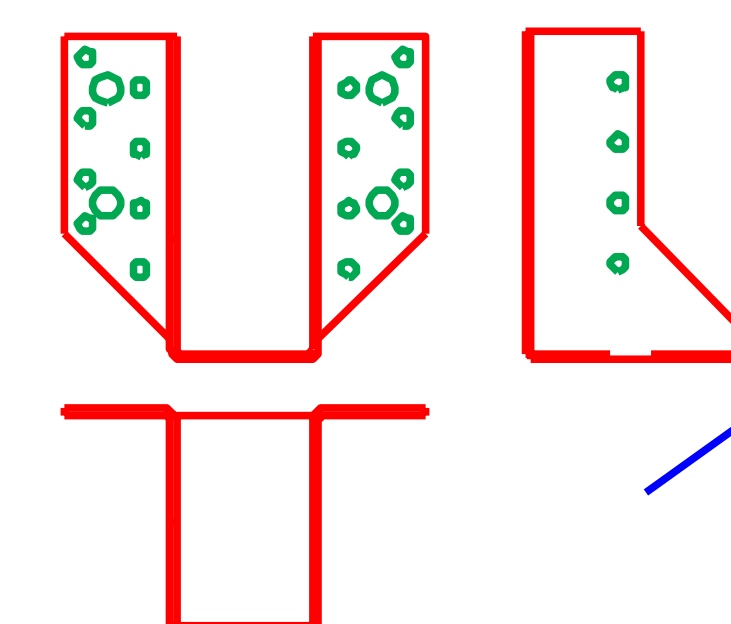
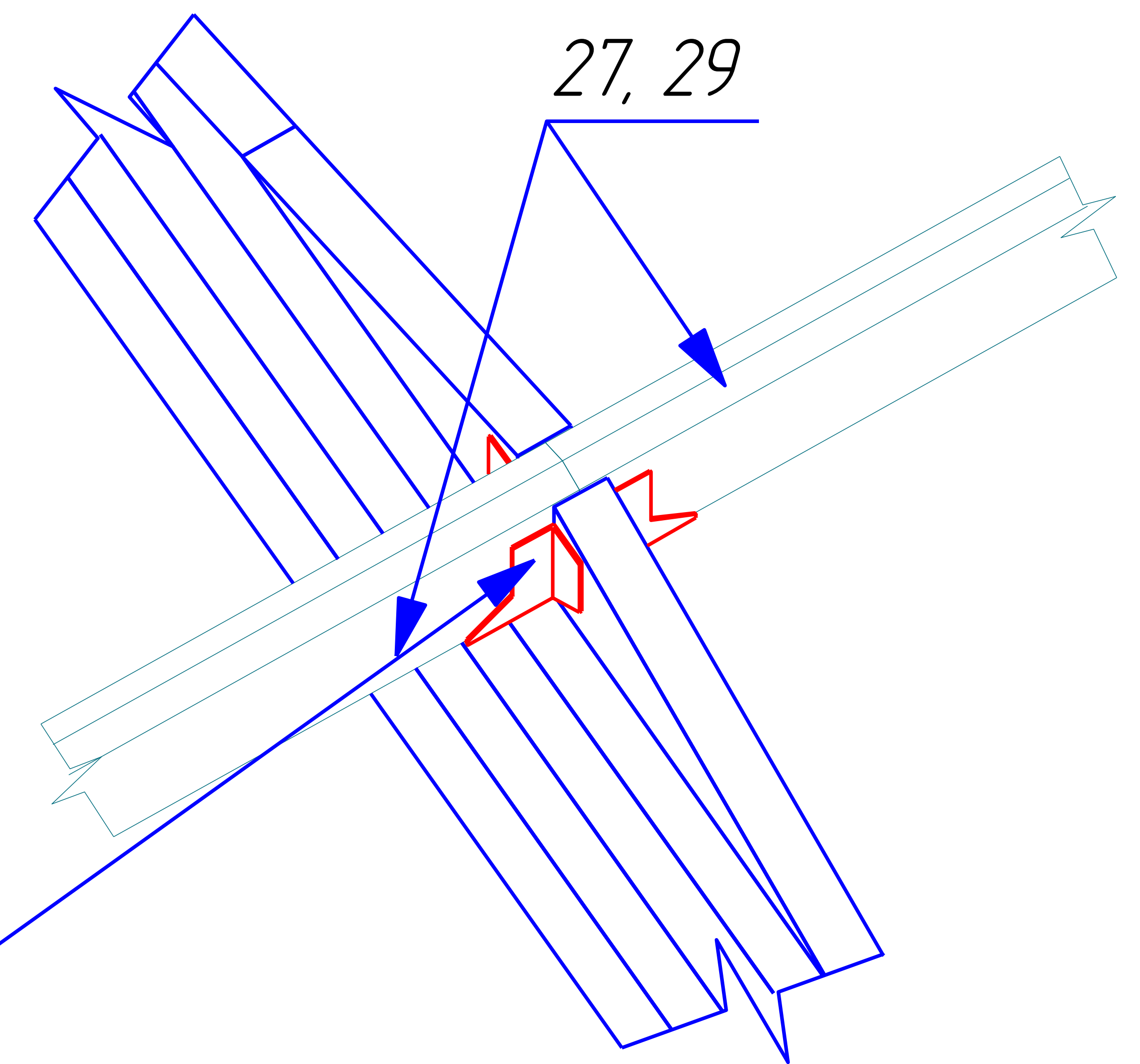

OAK 44 6x3

Plan

Стена B
Wand B
Wall B
Mur B

Стена E
Wand E
Wall E
Mur E

Стена C
Wand C
Wall C
Mur C

Стена D
Wand D
Wall D
Mur D

15.4 m²

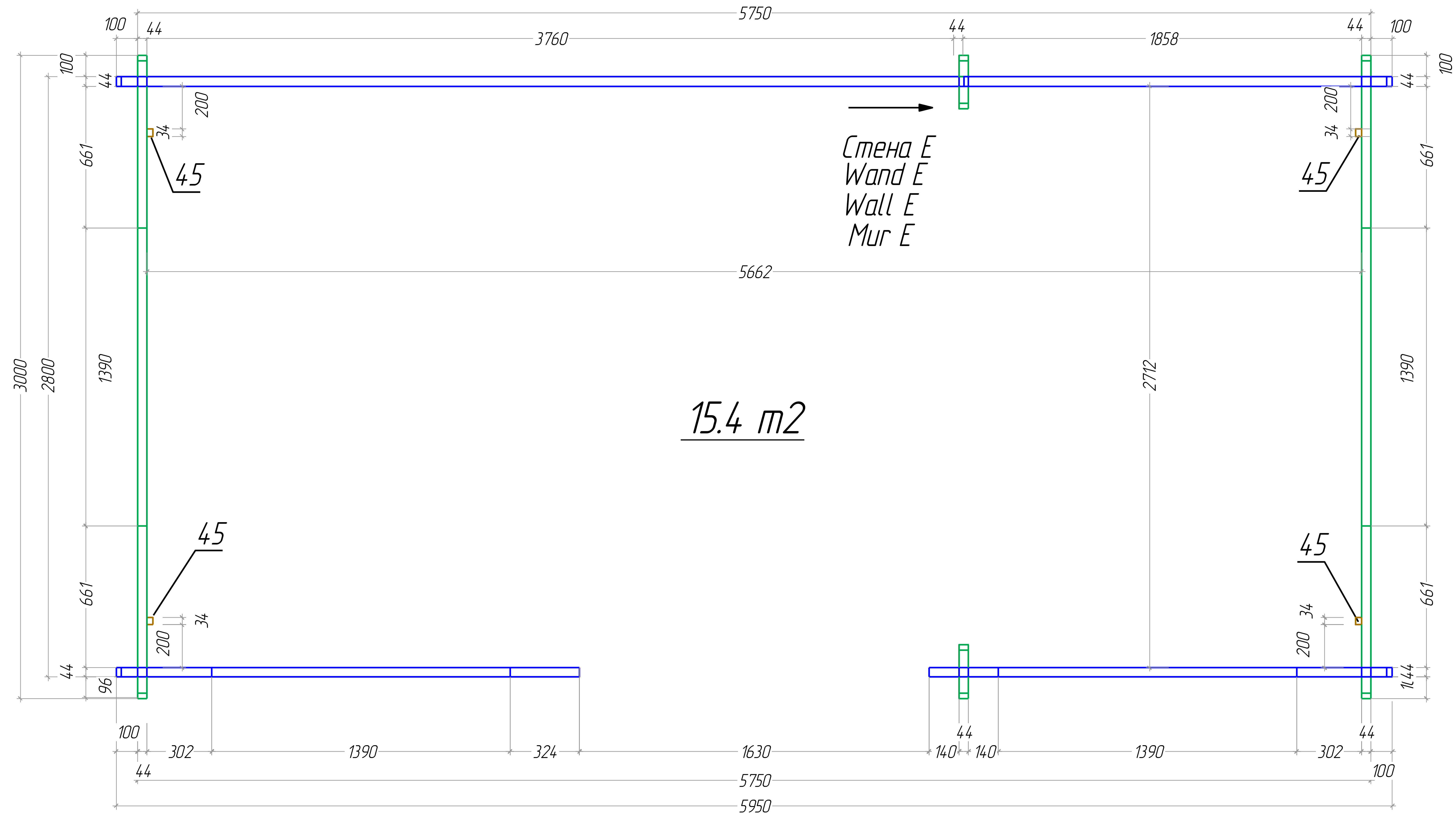

Стена A
Wand A
Wall A
Mur A

M 1:30

OAK 44 6x3

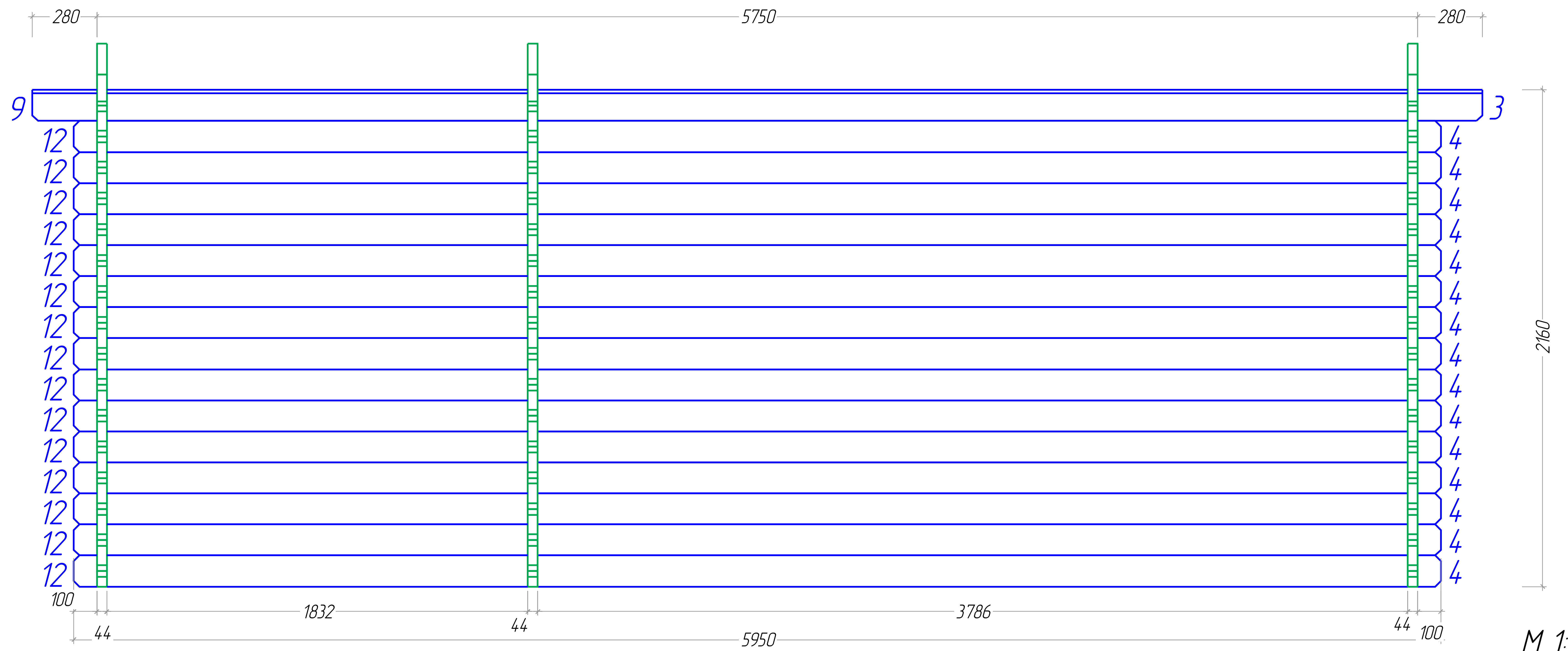
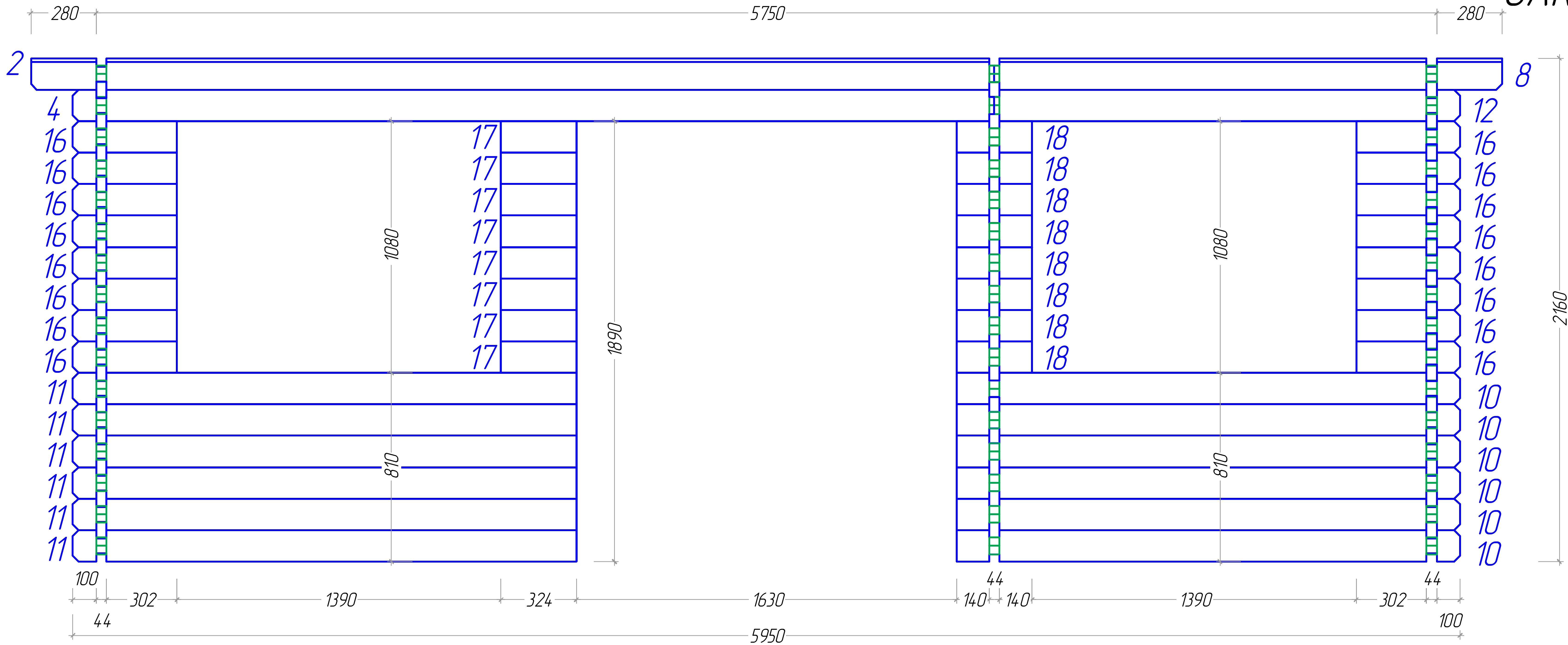

M 1:30

OAK 44 6x3

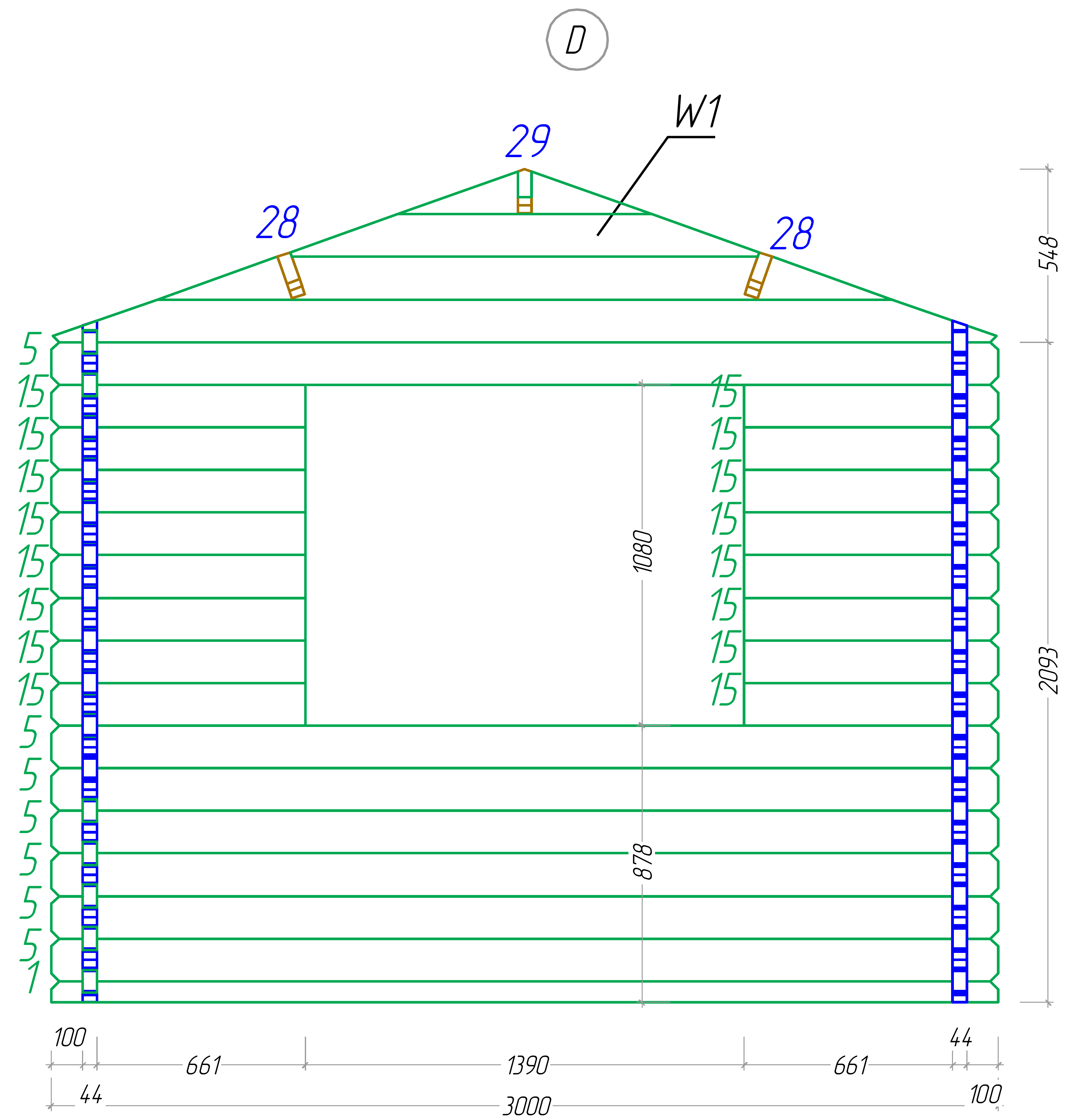
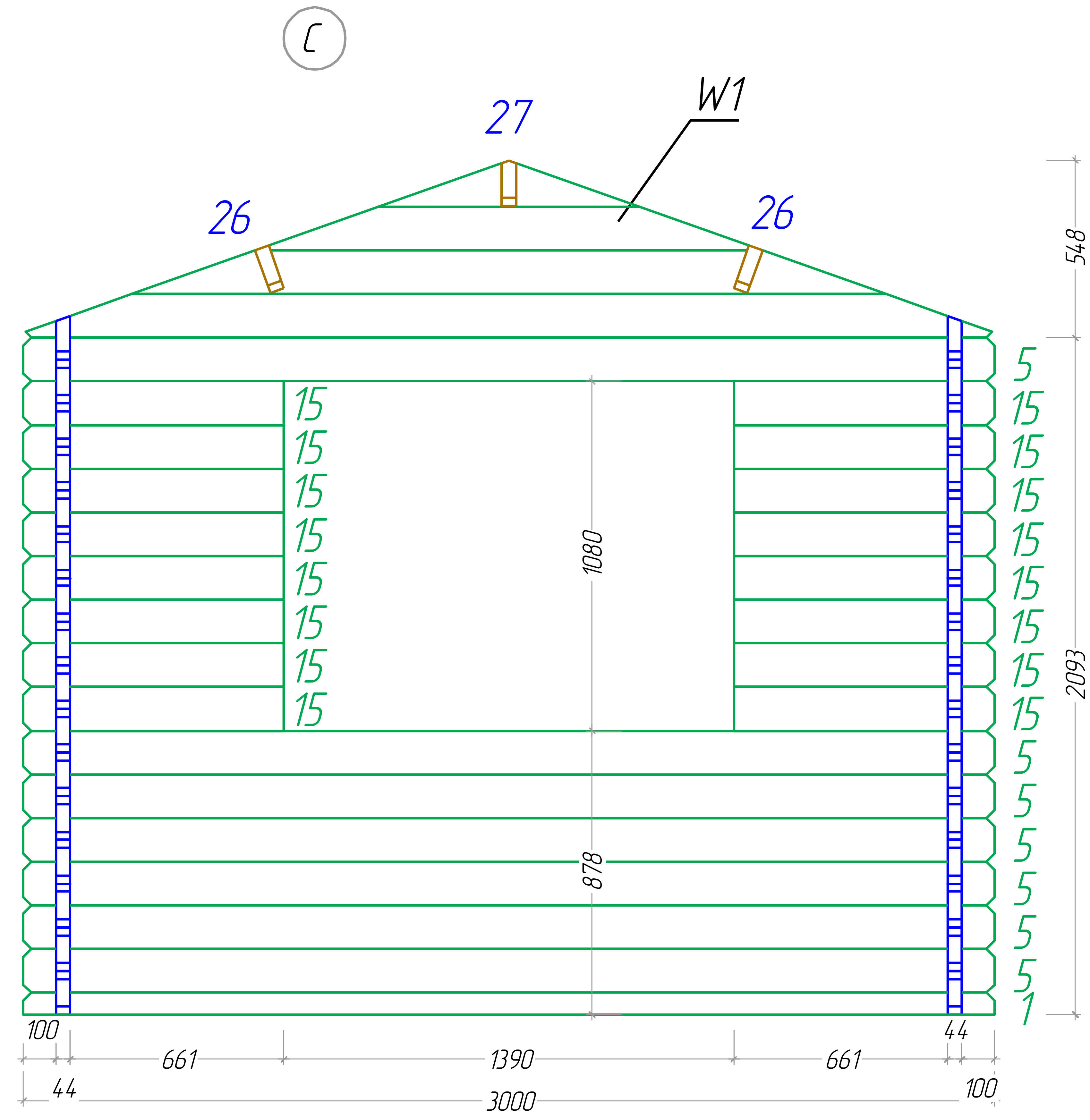

M 1:30

Ⓔ

OAK 44 6x3

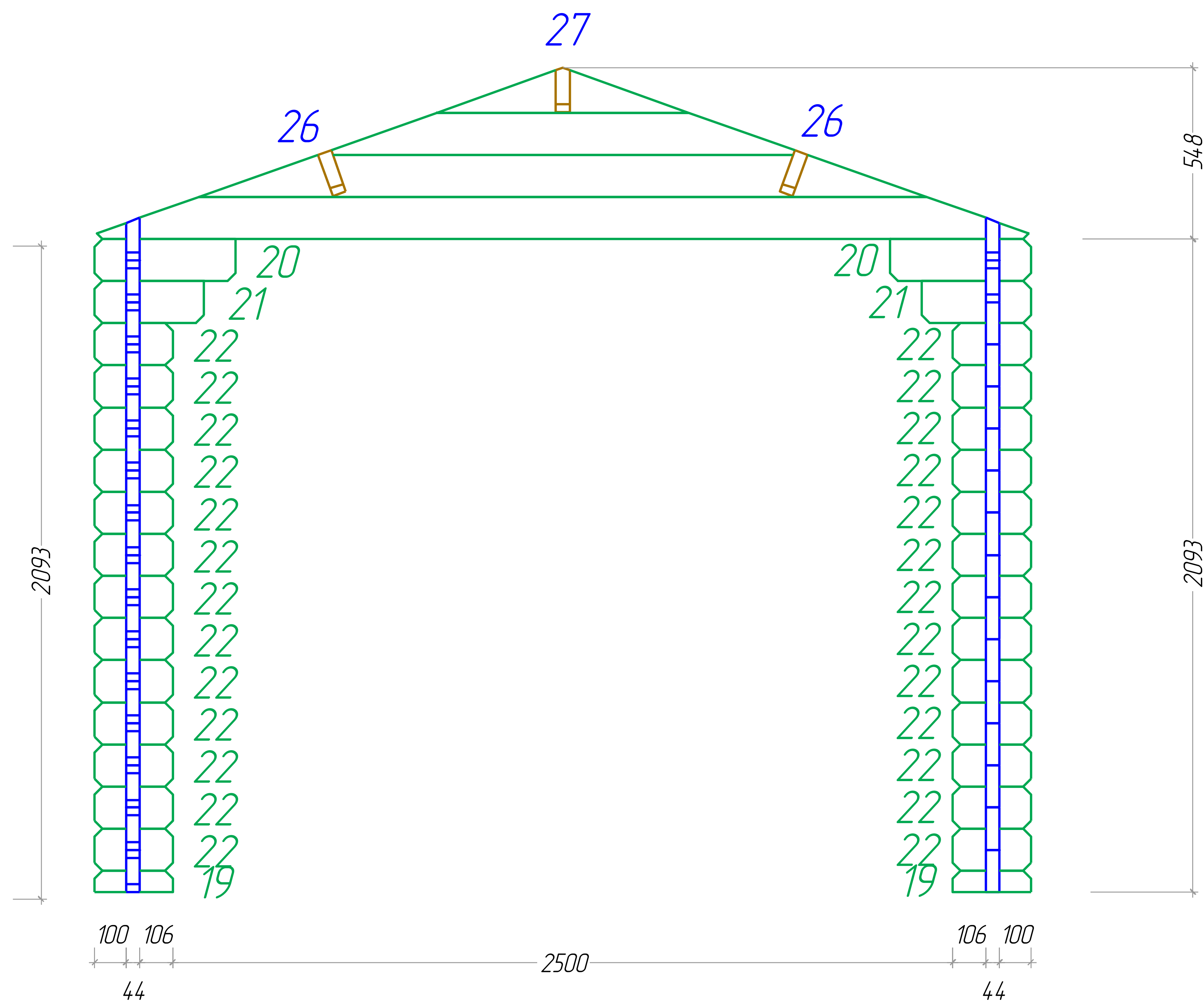

OAK 44 6x3

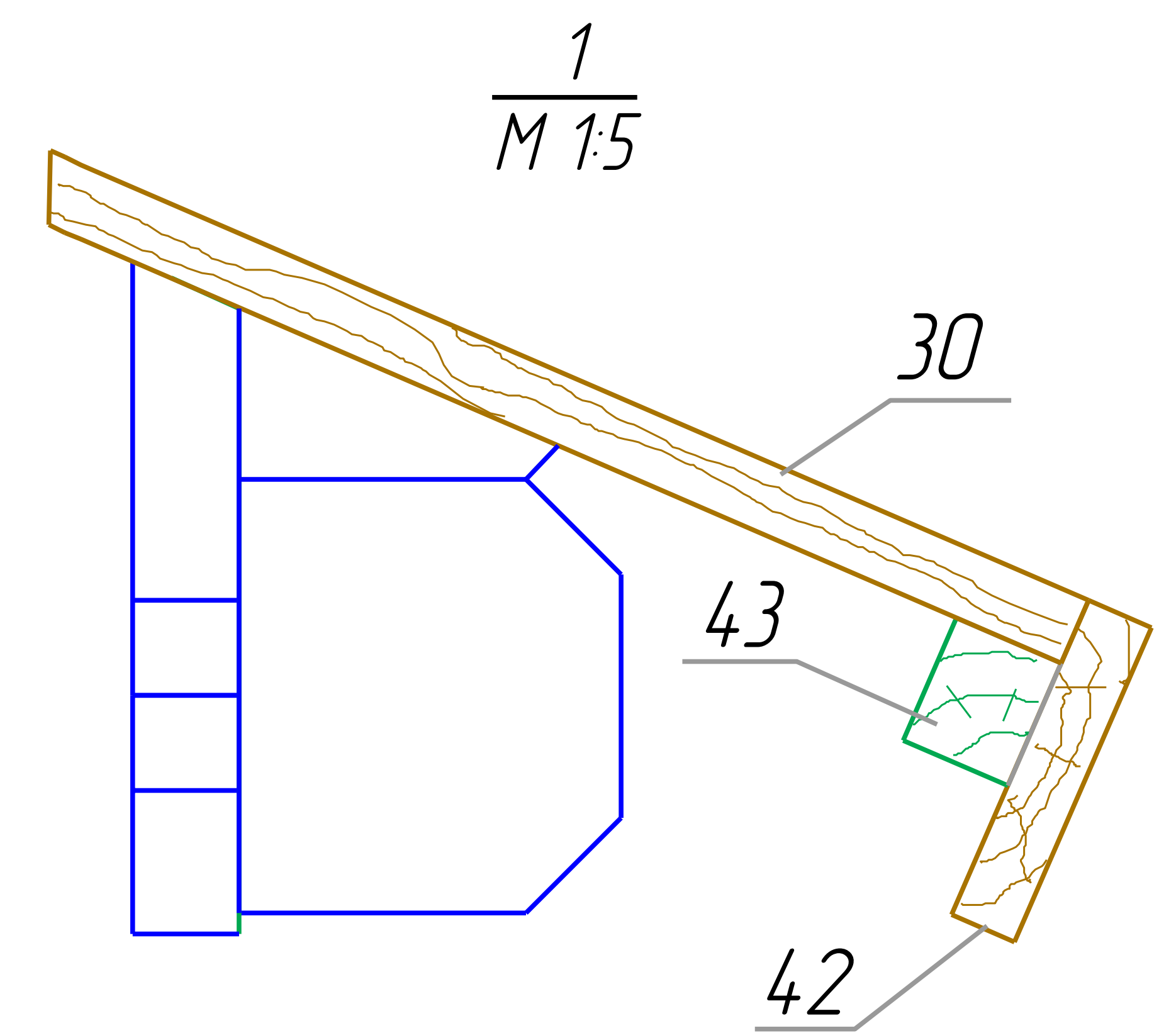
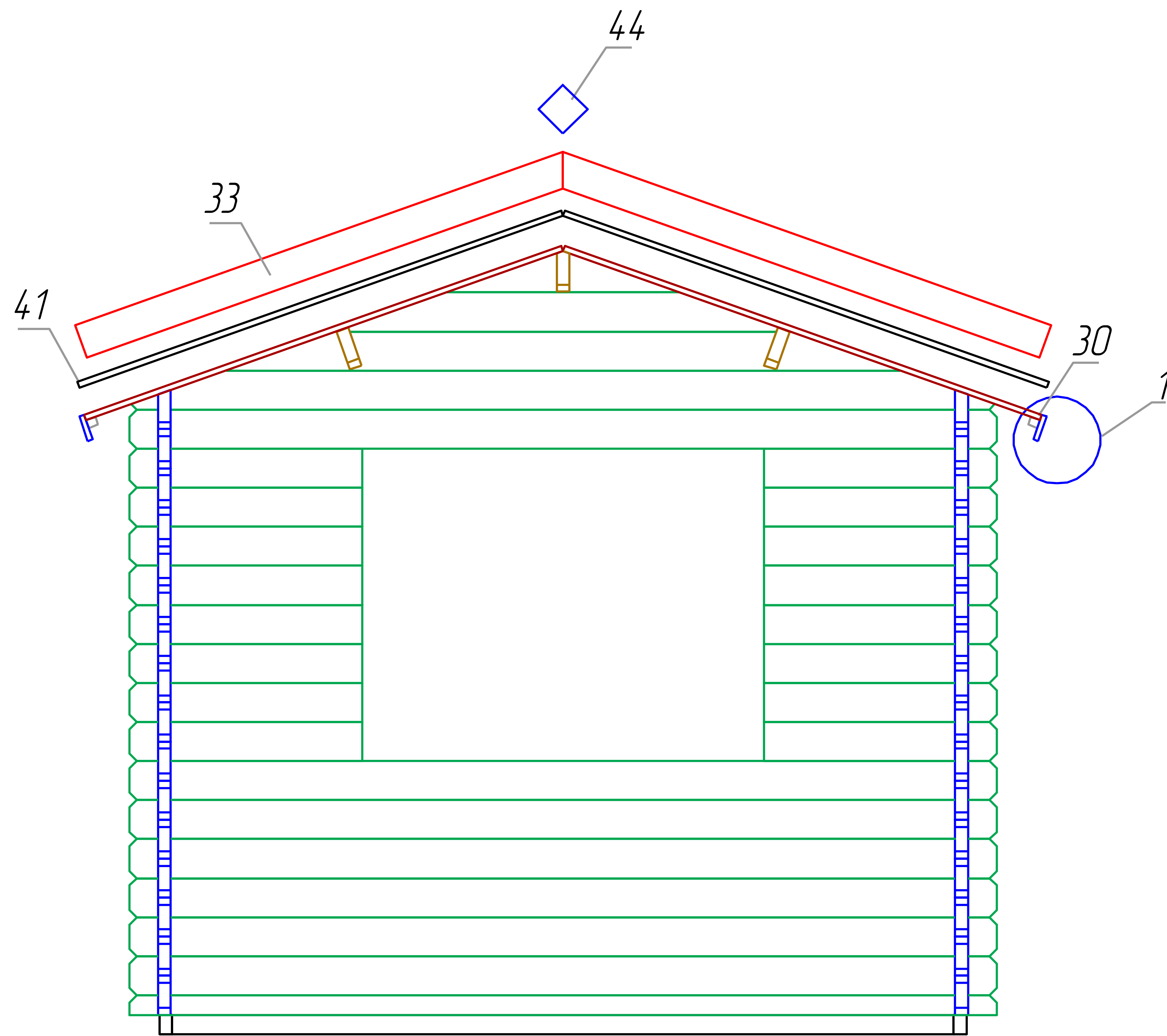

M 1:30

OAK 44 6x3

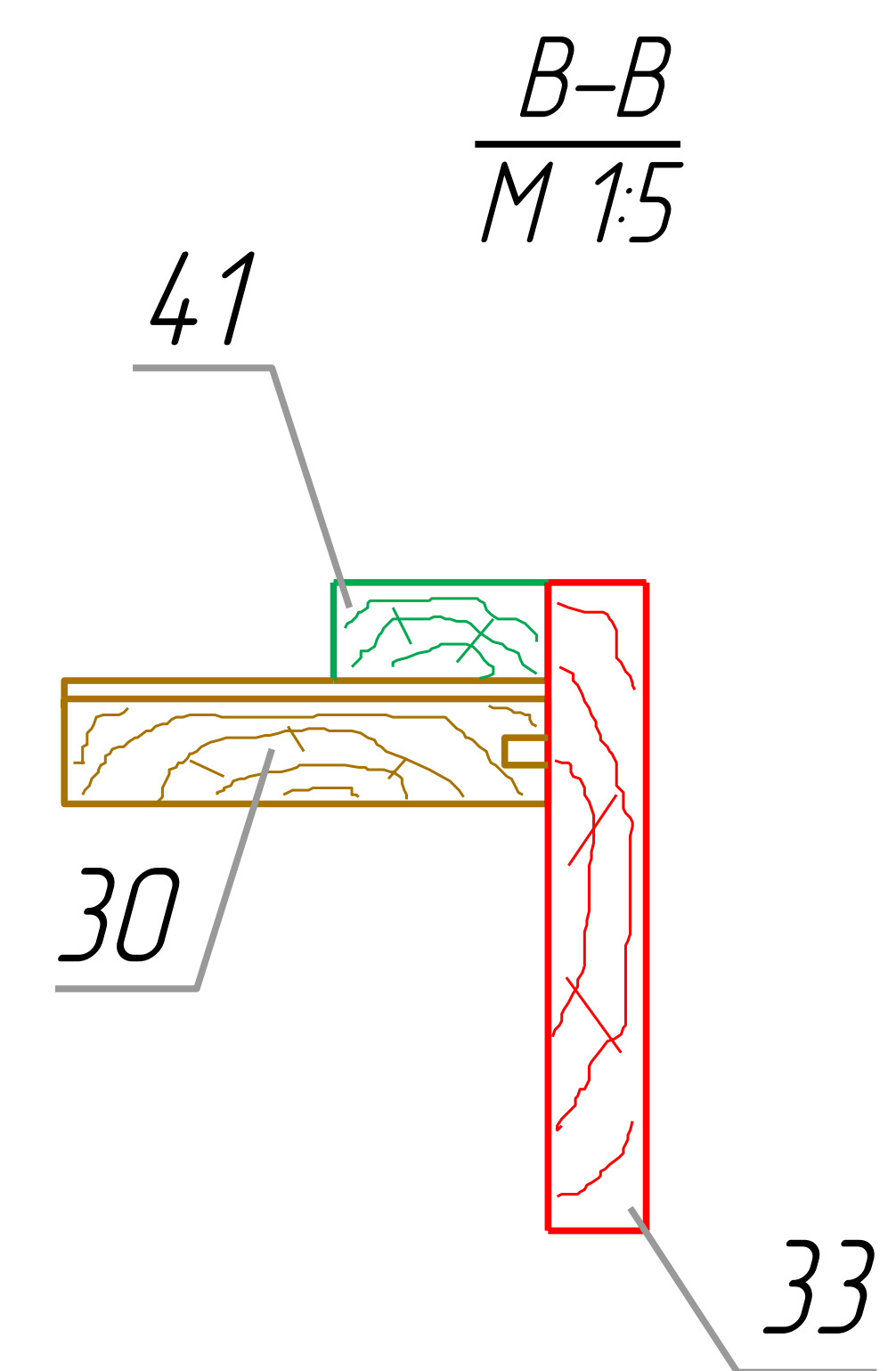
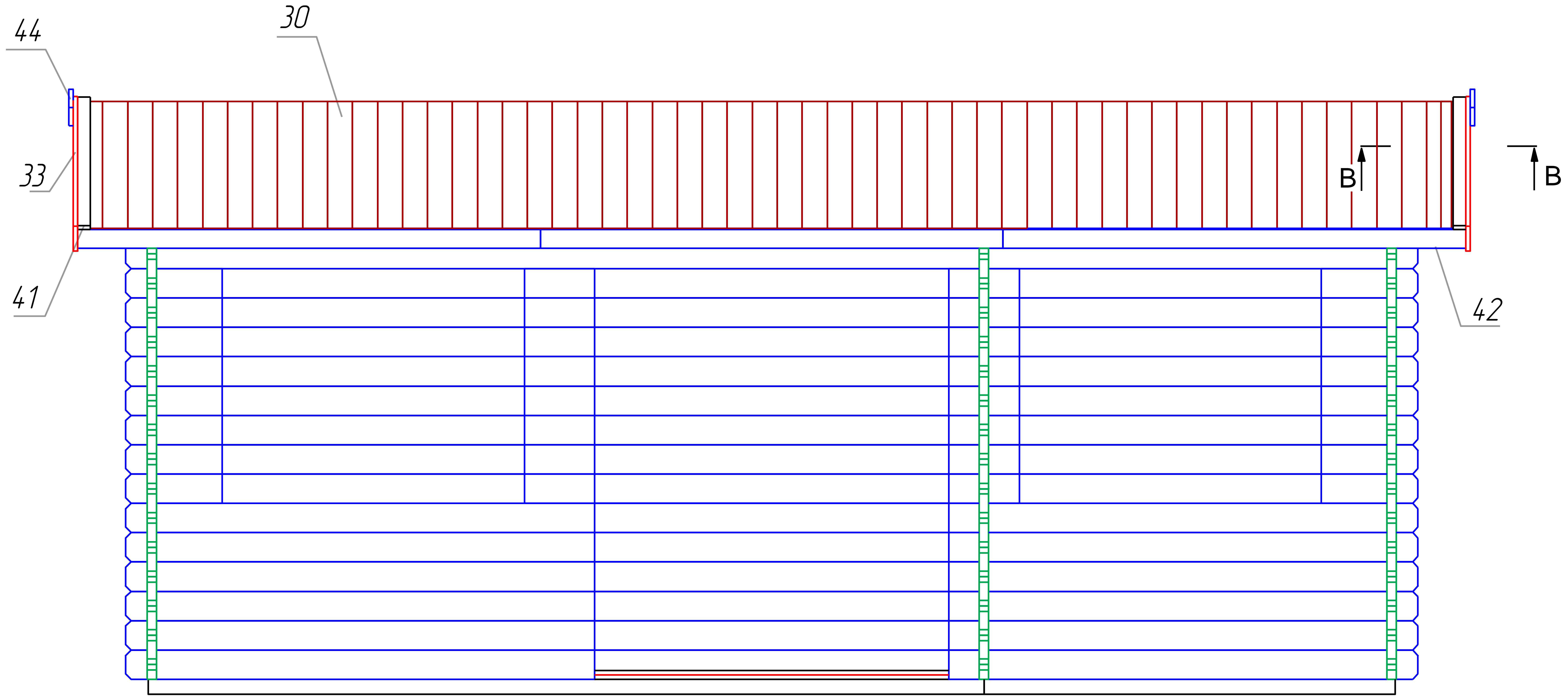

M 1:30

OAK 44 6x3

Boarding joist plan

Trummplan

Lambourde plan

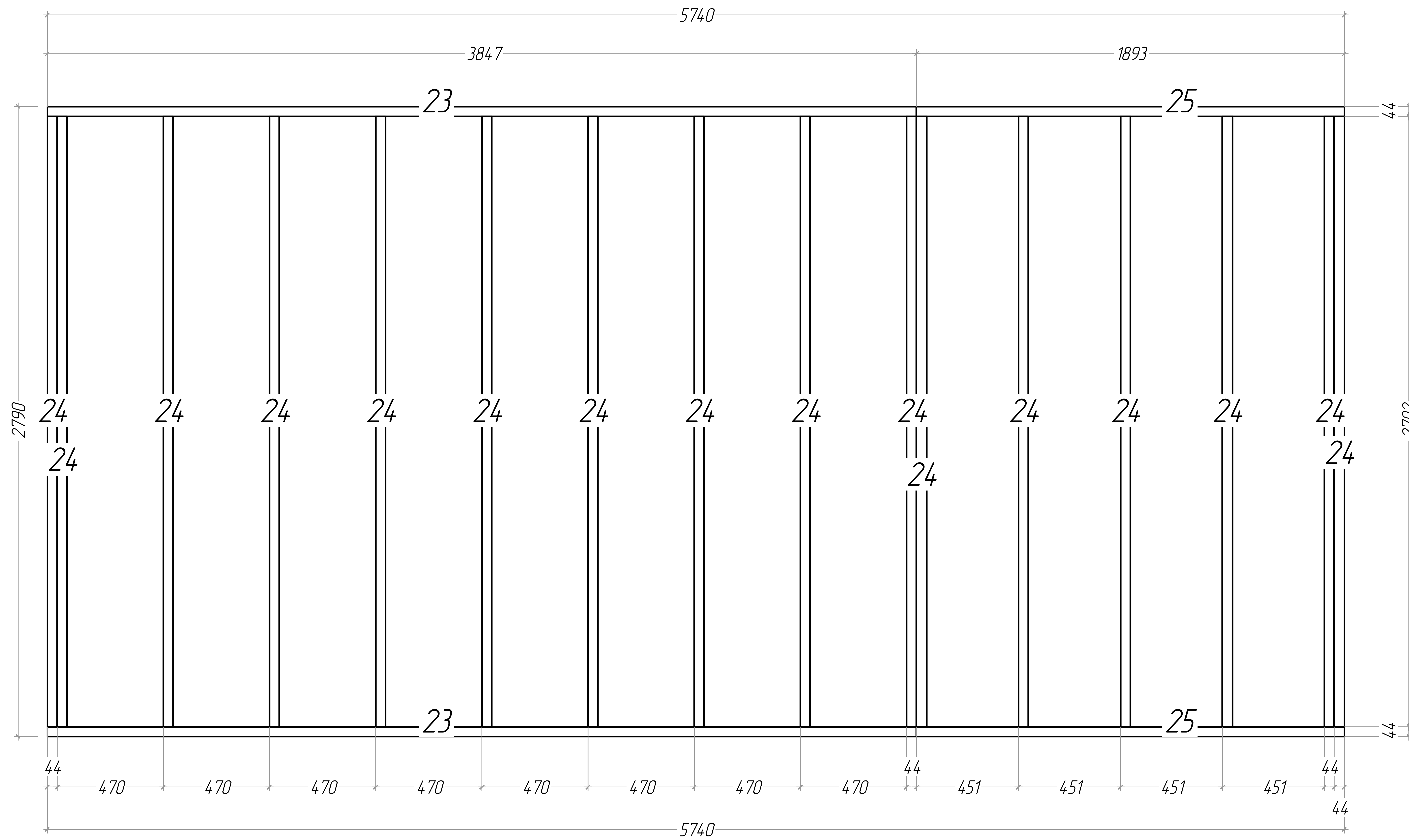





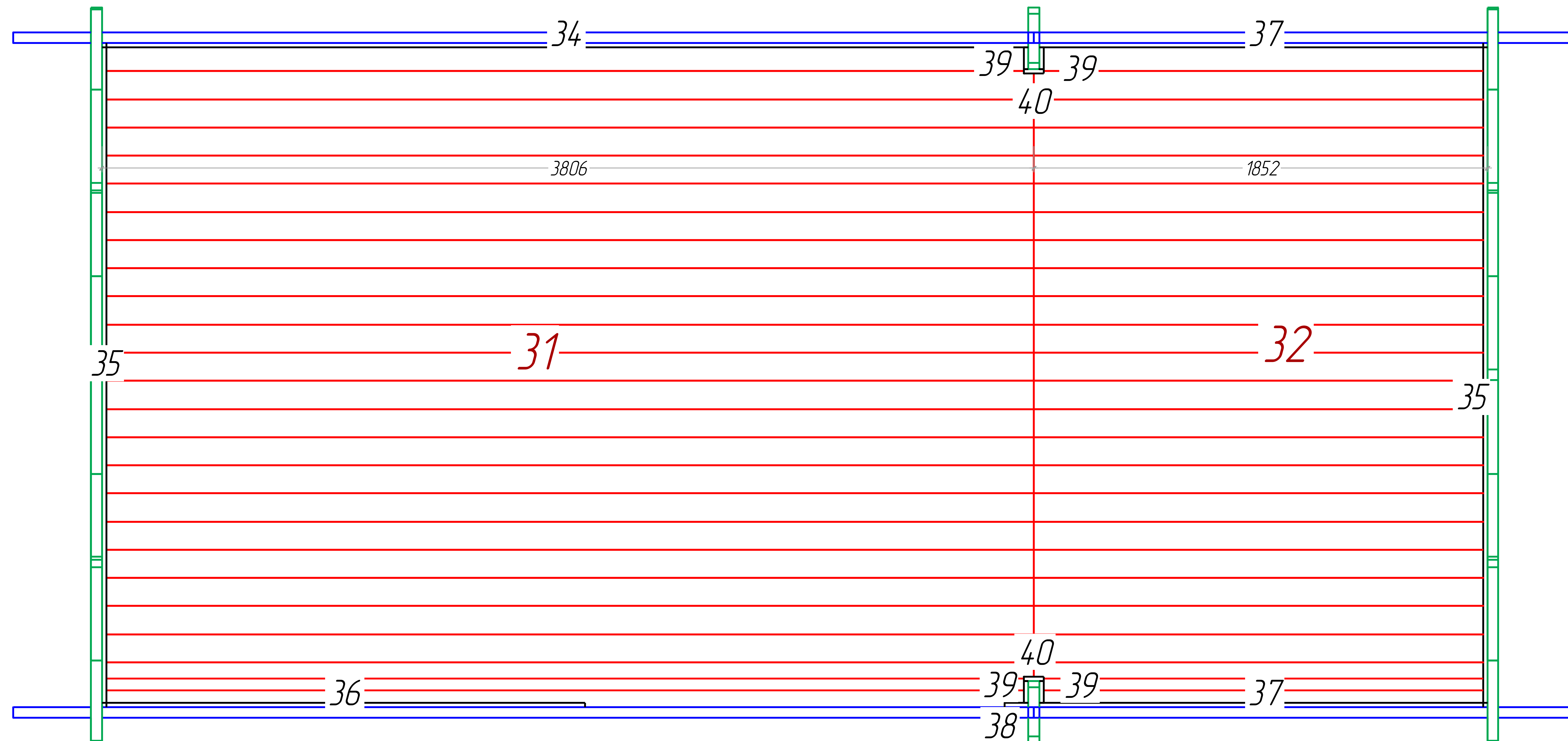

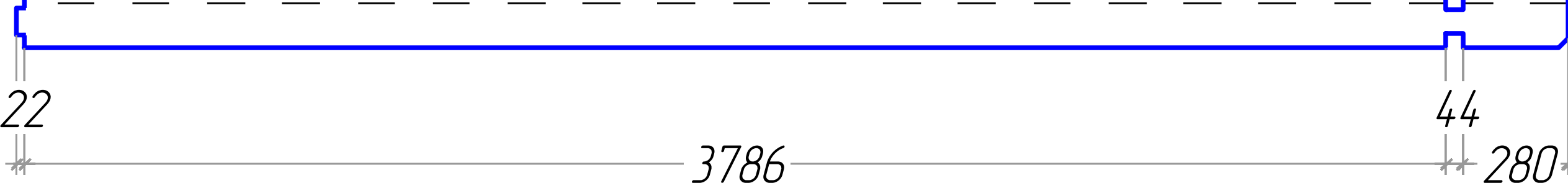
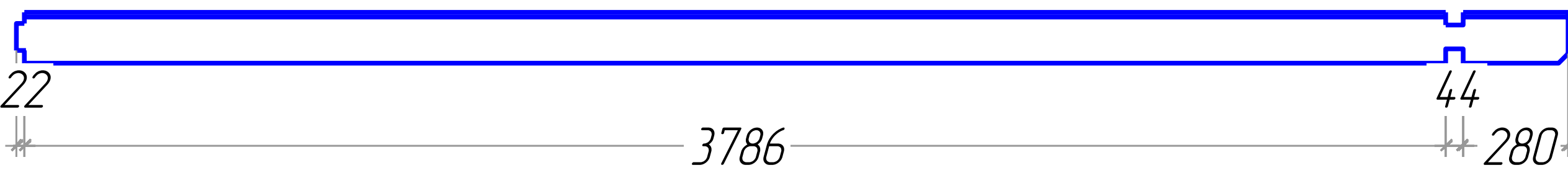
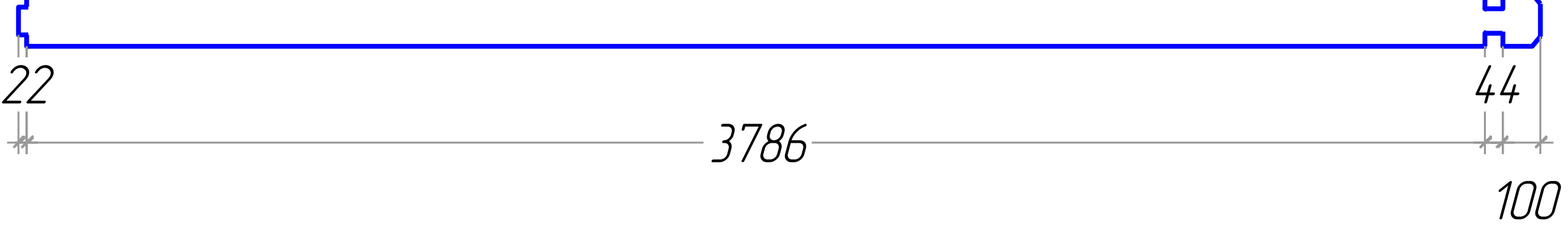
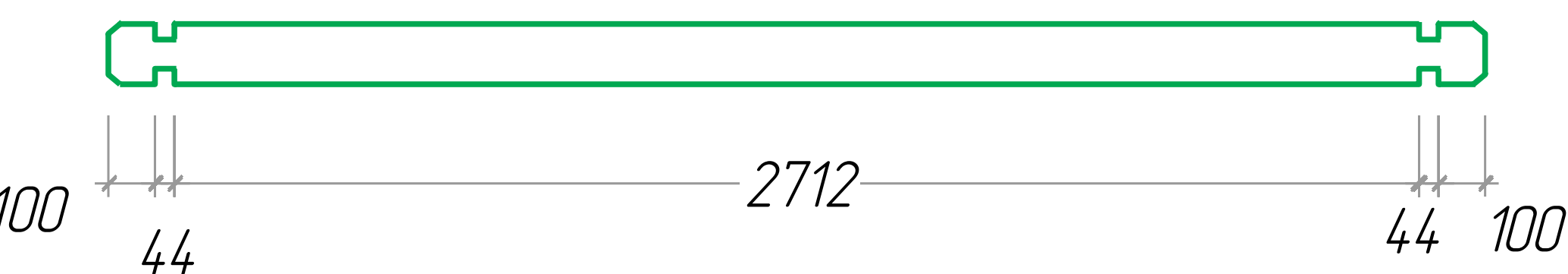
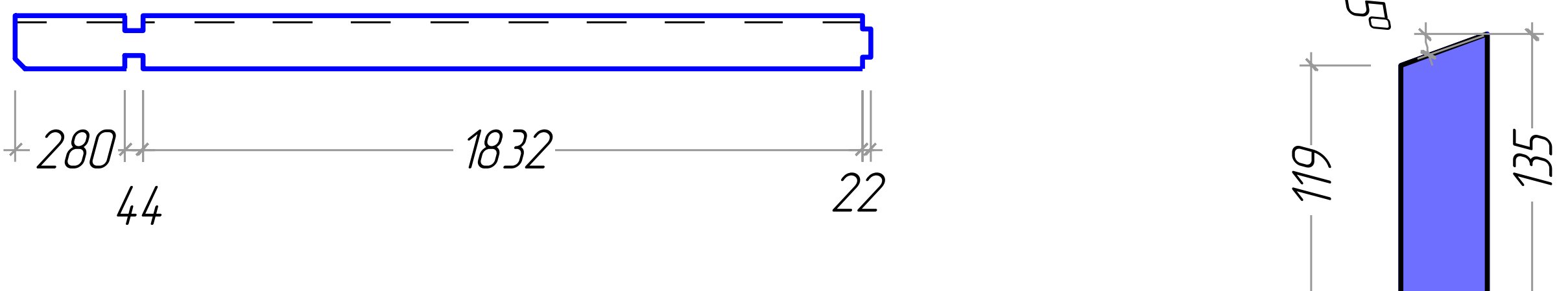
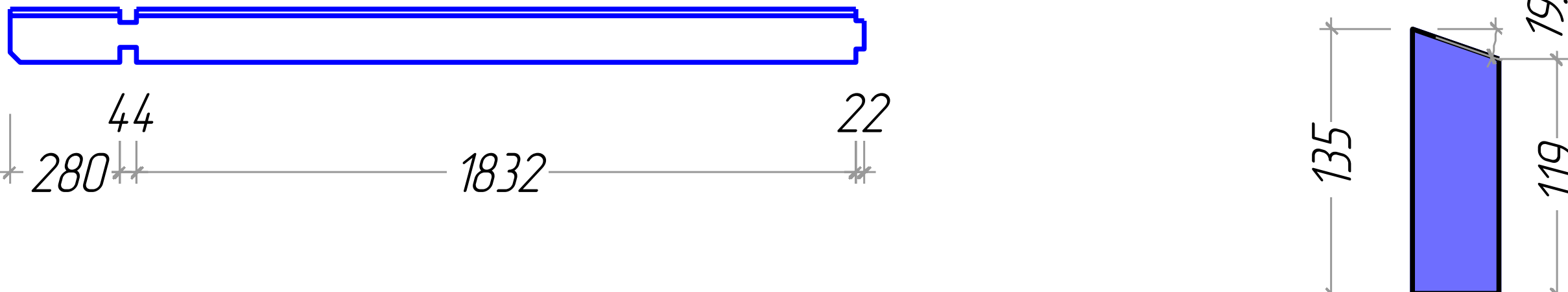
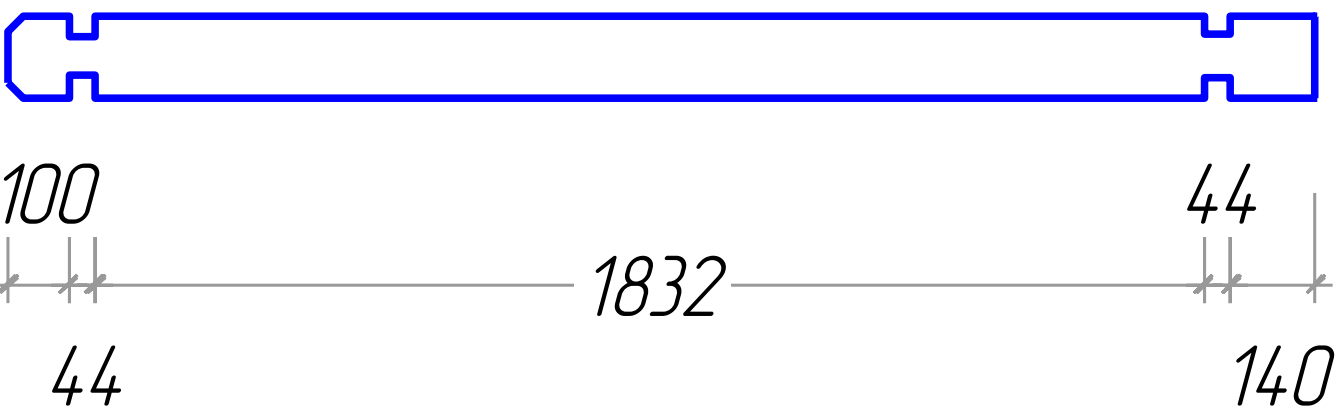
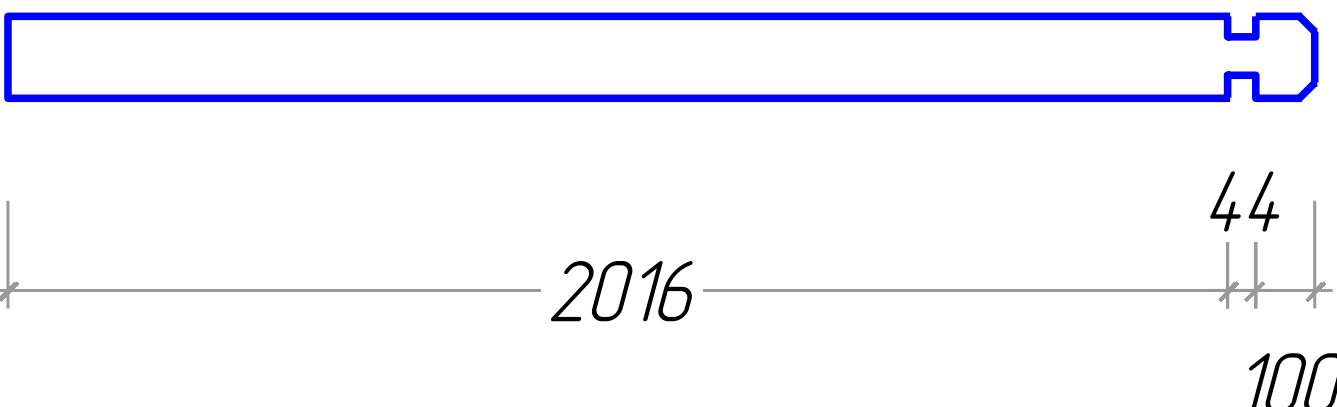
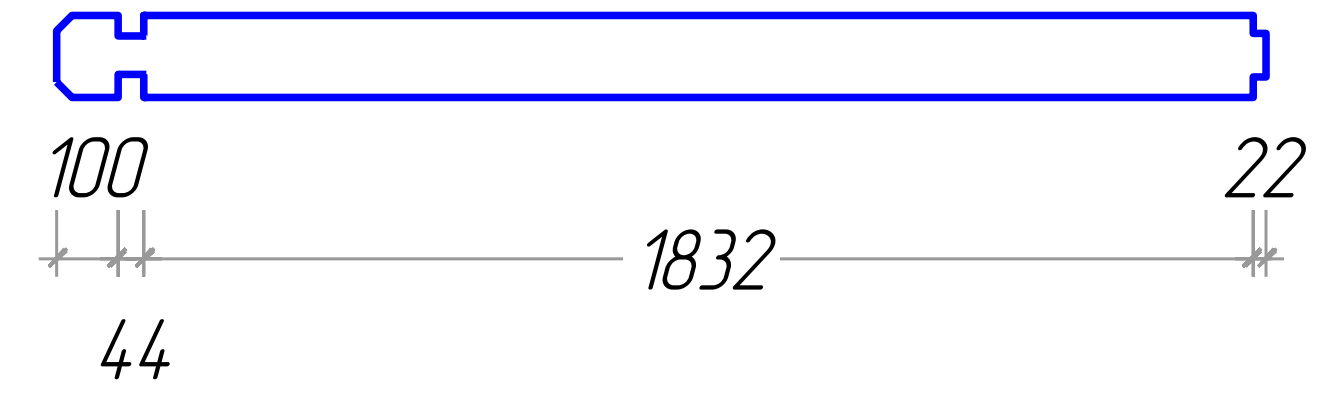
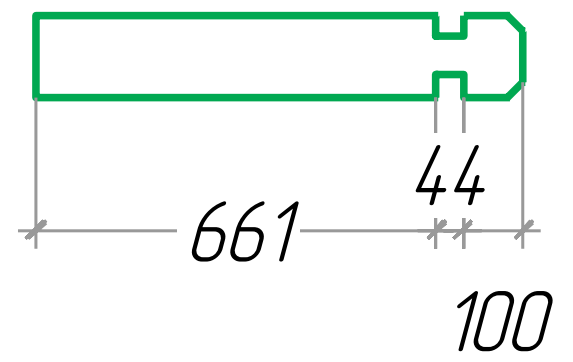
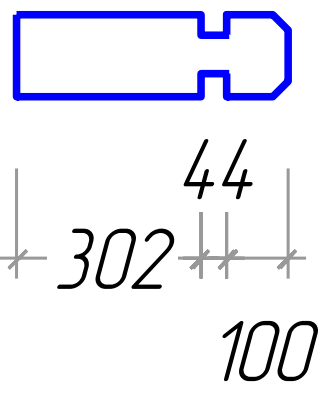
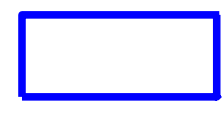

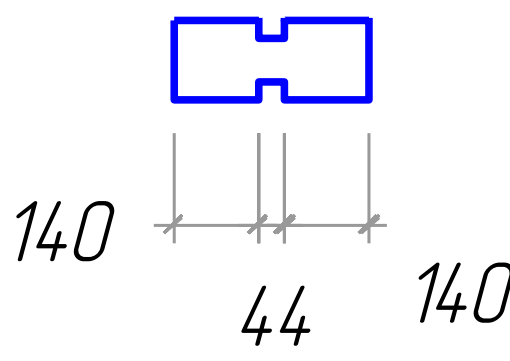
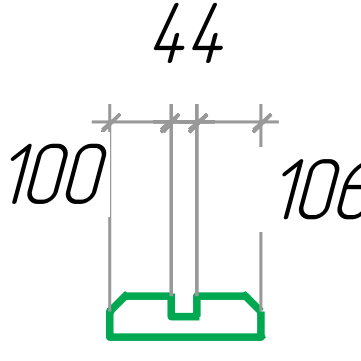
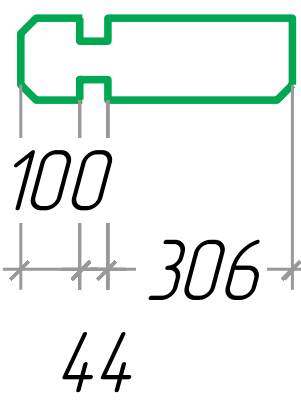
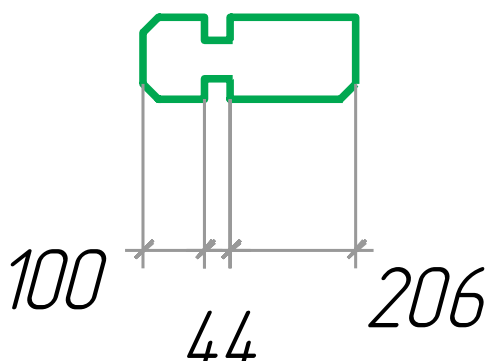
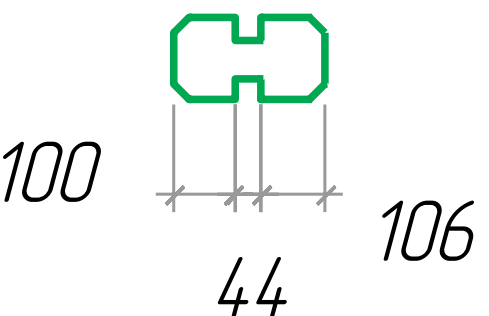



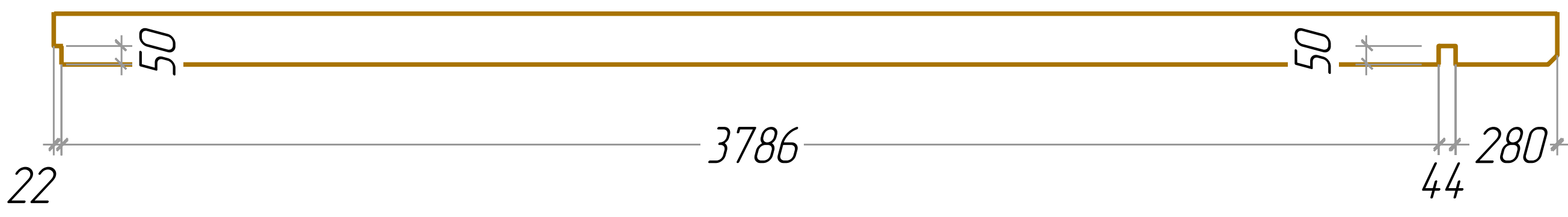
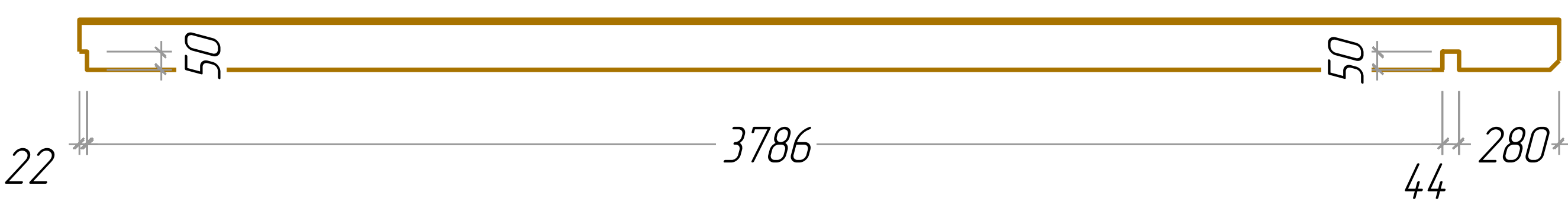
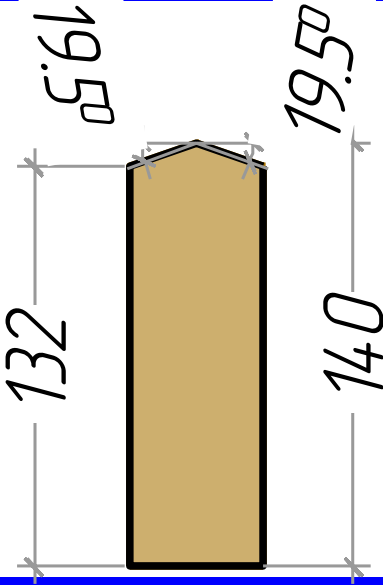
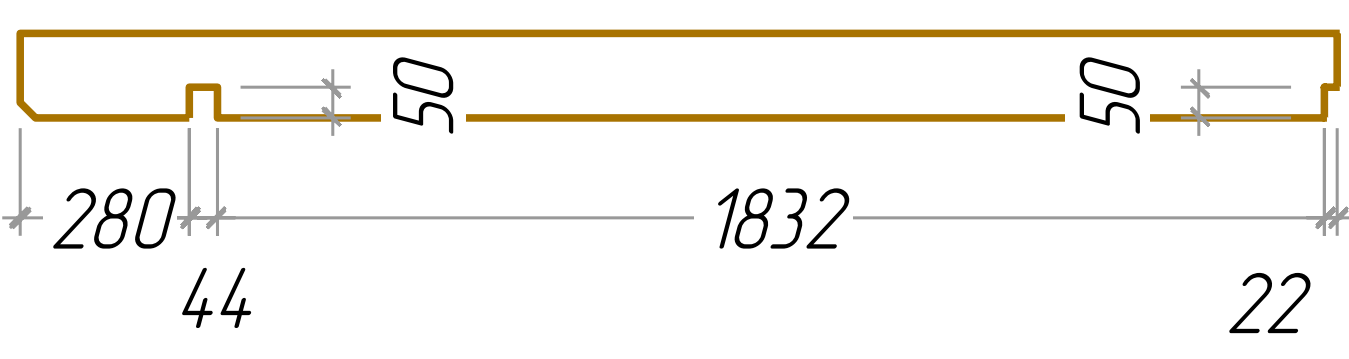
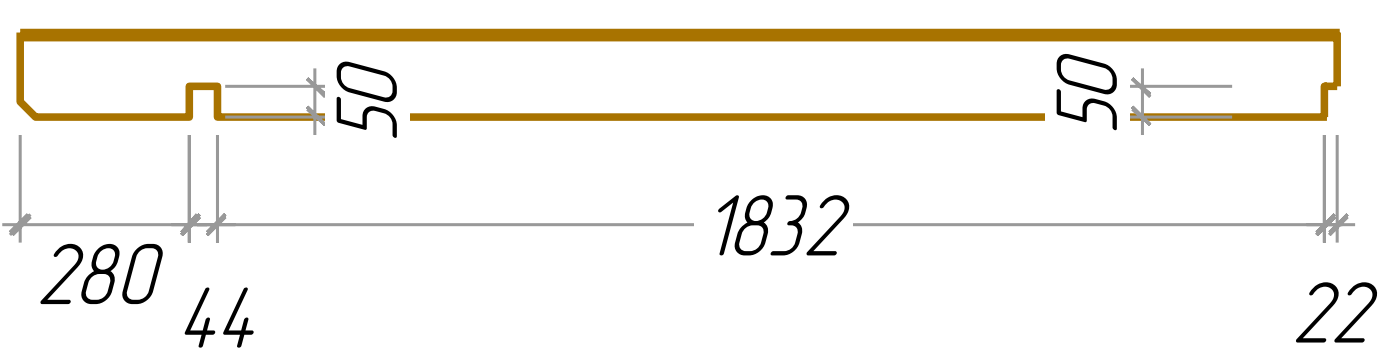
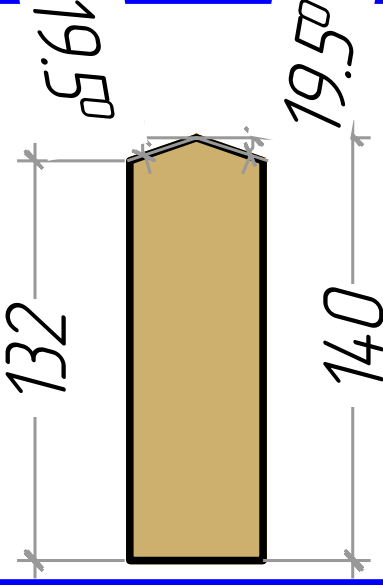
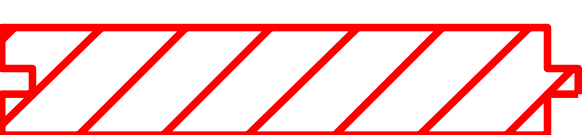

OAK 44 6x3

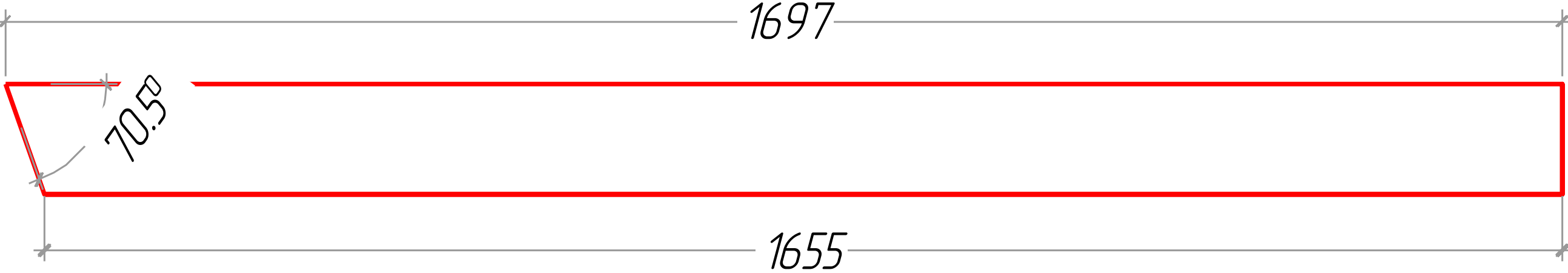

Plan of the floor board
Plan der Furbodenbretter
Le plan des plaches du plancher

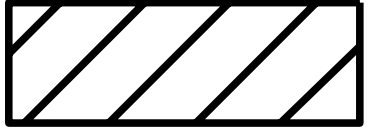
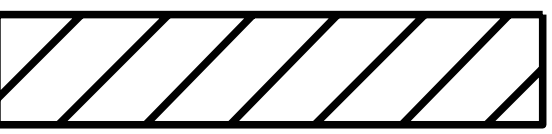
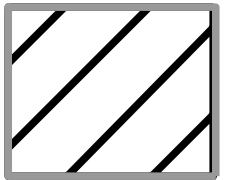

Nº	OAK 44 6x3	Nr.	Profile (mm)	Length (mm)
1		2	44x67,5	3000mm
2		1	44x135	4132mm
3		1	44x135	4132mm
4		16+1	44x135	3952mm
5		14	44x135	3000mm
8		1	44x135	2178mm
9		1	44x135	2178mm
10		6	44x135	2160mm
11		6	44x135	2160mm
12		16+1	44x135	1998mm
15		32	44x135	805mm
16		16	44x135	446mm
17		8	44x135	324mm

Nº	OAK 44 6x3	Nr.	Profile (mm)	Lenght (mm)
18		8	44x135	324mm
19		2	44x67,5	250mm
20		2	44x135	450mm
21		2	44x135	350mm
22		26	44x135	250mm
23	<i>Foundation Fundament Solive</i> 	2	44x68	3847mm
24	<i>Foundation Fundament Solive</i> 	16	44x68	2702mm
25	<i>Foundation Fundament Solive</i> 	2	44x68	1893mm
26	<i>Roof beam. Dachbalken. Panne</i> 	2	44x140	4132mm
27	<i>Roof beam. Dachbalken. Panne</i>  	1	44x140	4132mm
28	<i>Roof beam. Dachbalken. Panne</i> 	2	44x140	2178mm
29	<i>Roof beam. Dachbalken. Panne</i>  	1	44x140	2178mm
30	<i>Roof boards Dachbretter Volige</i> 	110+1	20x115	1657mm

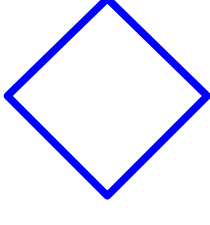
Nº	OAK 44 6x3	Nr.	Profile (mm)	Lenght (mm)
31	Floor boards Fu ssboden Lame de plancher 	24+1	20x115	3806mm
32	Floor boards Fu ssboden Lame de plancher 	24+1	20x115	1852mm
33	Fascia board Giebelblende Planch de rive facade 	4	20x120	1697mm
34	Floor edge trim Fu bleisten Plinthe plancher 	1	20x18	3786mm
35	Floor edge trim Fu bleisten Plinthe plancher 	2	20x18	2712mm
36	Floor edge trim Fu bleisten Plinthe plancher 	1	20x18	1973mm
37	Floor edge trim Fu bleisten Plinthe plancher 	2	20x18	1832mm
38	Floor edge trim Fu bleisten Plinthe plancher 	1	20x18	97mm
39	Floor edge trim Fu bleisten Plinthe plancher 	4	20x18	88mm
40	Floor edge trim Fu bleisten Plinthe plancher 	2	20x18	80mm
41	Roofing felt fillet Giebelabschlussbrett Latte de finition couverture 	4	20x58	1683mm
42	Roof side boards Traufenbrett Planche de rive 	6	18x90	2103mm
43	Roof edge reinforcement Traufenteile Tasseau 	6	28x34	2103mm

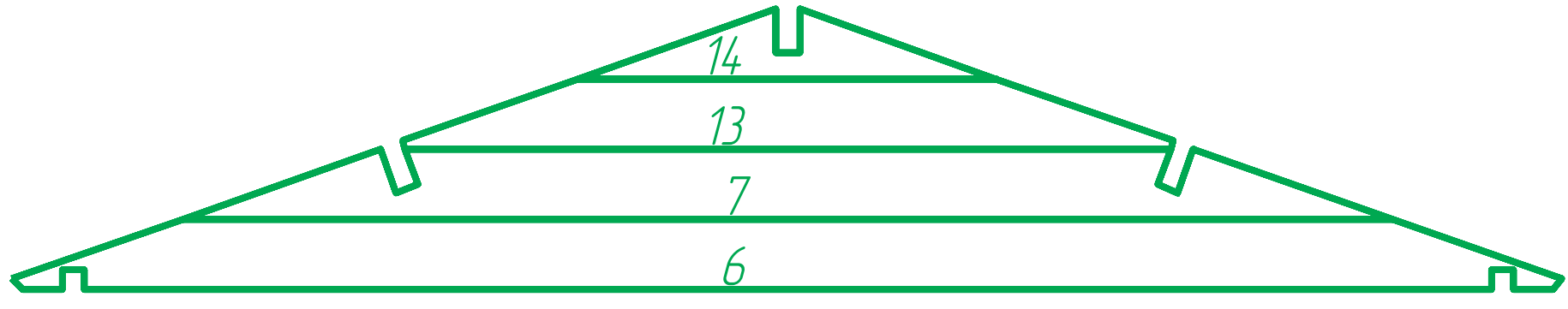
N°	OAK 44 6x3	Nr.	Profile (mm)	Lenght (mm)
44	Diamond Raute Diamant 	2	20x120	120mm
45	Storm protection 	4	28x34	1900mm
	Door Tur La porte 1890x1630MM	1		
	Window Fenetre Fenster 1080x1390MM	4		
W-1		3		

OAK 44 6x3

W-1

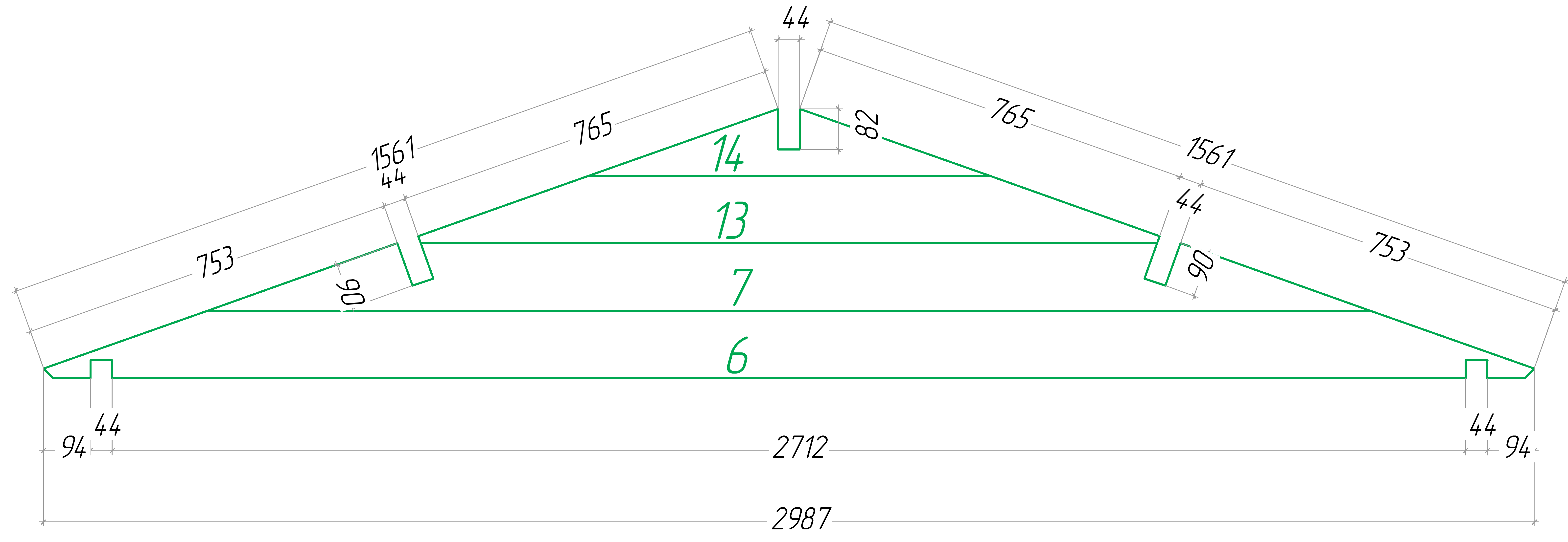

Storm protection

